



PROGRAMMABLE CONTROLLERS
MELSEC-F

FX-USB-AW USER'S MANUAL



| | |
|---------------|-------------|
| Manual Number | JY997D13201 |
| Revision | N |
| Date | April 2015 |

This manual describes the part names, dimensions, mounting, and specifications of the product. Before use, read this manual and the manuals of all relevant products fully to acquire proficiency in handling and operating the product. Make sure to learn all the product information, safety information, and precautions. Store this manual in a safe place so that it can be taken out and read whenever necessary. Always forward it to the end user.

Registration: Microsoft®, Windows® and Windows Vista® are either registered trademarks or trademarks of Microsoft Corporation in the United States and/or other countries. The company and product names described in this manual are registered trademarks or the trademarks of their respective companies

Effective April 2015
Specifications are subject to change without notice.
© 2004 Mitsubishi Electric Corporation

Safety Precaution (Read these precautions before use.)

This manual classifies the safety precautions into two categories:

WARNING and **CAUTION**

| | |
|----------------|---|
| WARNING | Indicates that incorrect handling may cause hazardous conditions, resulting in death or severe injury. |
| CAUTION | Indicates that incorrect handling may cause hazardous conditions, resulting in medium or slight personal injury or physical damage. |

Depending on the circumstances, procedures indicated by **CAUTION** may also cause severe injury. It is important to follow all precautions for personal safety.

Associated Manuals

| Manual name | Manual No. | Description |
|--|-----------------------------------|---|
| FX-USB-AW /FX3U-USB-BD User's Manual - USB Driver Installation Edition | JY997D32601 | Explains procedures for installing the USB driver software for the FX-USB-AW or FX3U-USB-BD. |
| FX Series User's Manual - Data Communication Edition | JY997D16901 MODEL CODE: 09R715 | Explains N:N network, Parallel Link, Computer Link, Non-Protocol communication by RS and RS2 instructions/FX2N-232IF. |

How to obtain manuals

For product manuals or documents, consult with the Mitsubishi Electric dealer from who you purchased your product.

Notification of CE marking

This notification does not guarantee that an entire mechanical module produced in accordance with the contents of the notification comply with the following standards. Compliance to EMC standards of the entire mechanical module should be checked by the user / manufacturer.

Attention

- This product is designed for use in industrial applications.

Note

- Authorized Representative in the European Community:
Mitsubishi Electric Europe B.V.
Gothaer Str. 8, 40880 Ratingen, Germany

Standards with which this product complies

Type: Programmable Controller (Open Type Equipment)
Models: Products manufactured from August 1st, 2004.

| Electromagnetic Compatibility Standards (EMC) | Remark |
|--|---|
| EN61000-6-4:2007 Generic emission standard Industrial environment | Compliance with all relevant aspects of the standard. (Emission-Enclosure port, Emission-Low voltage AC mains port and Emission-Telecommunications/network port) |
| EN61131-2:2007 Programmable controllers - Equipment requirements and tests | Compliance with all relevant aspects of the standard. (Radiated Emission, Conducted Emission, Radiated electromagnetic field, Fast transient burst, Electrostatic discharge, High-energy surge, Voltage drops and interruptions, Conducted RF and Power frequency magnetic field) |
| EN61000-6-2:2005 - Generic immunity standard Industrial environment | Compliance with all relevant aspects of the standard. (Radio-frequency electromagnetic field, Amplitude modulated, Fast transients, Electrostatic discharge, Surges, Voltage dips, Voltage interruptions, Radio-frequency common mode and Power-frequency magnetic field) |

Notes for compliance to EMC regulation.

It is necessary to install the (FX-USB-AW) in a shielded metal control panel. For more details please contact the local Mitsubishi Electric sales site.

1. Outline

The FX-USB-AW is a RS-422/USB conversion interface unit to connect the FX series PLC to a personal computer with USB ports.

1.1 Incorporated Items

Verify that the following product and items are included in the package:

| Product | FX-USB-AW type interface unit |
|----------------|--|
| Included items | USB driver software (CD-ROM) USB cable (3m (118.1")) User's Manual (this manual) |

1.2 External Dimensions and Part Names

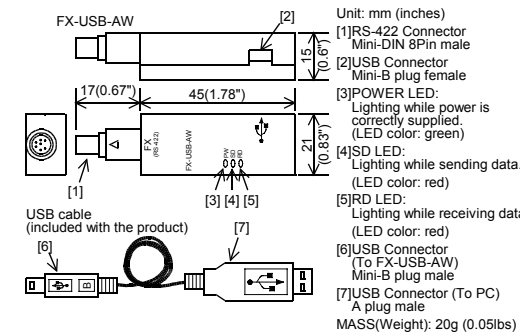

2. Specifications

INSTALLATION PRECAUTIONS



- Use the product within the generic environment specifications described in PLC main unit manual (Hardware Edition).
Never use the product in areas with excessive dust, oily smoke, conductive dusts, corrosive gas (salt air, Cl₂, H₂S, SO₂ or NO₂), flammable gas, vibration or impacts, or expose it to high temperature, condensation, or rain and wind.
If the product is used in such conditions, electric shock, fire, malfunctions, deterioration or damage may occur.

2.1 General Specifications

The general specifications are equivalent to the PLC main unit.
For general specifications, refer to the manual of the PLC main unit.

2.2 Performance Specifications of FX-USB-AW

| Current consumption | <ul style="list-style-type: none"> 15mA / 5V DC (5V DC power is supplied from the internal power supply of PLC) 30mA / 5V DC (5V DC power is supplied from the USB connector of personal computer) |
|---------------------|--|
|---------------------|--|

| | |
|-----------------------|---|
| Level Conversion | Bidirectional between RS-422 and USB (Between signals are isolated by photocoupler.) |
| Baud Rate | 115200 bps, maximum (The baud rate is different in PLC.) |
| Transmission standard | USB2.0 (For full speed) |
| Signal name (Port) | To PLC: RS-422 (Mini-DIN 8Pin male) To a cable: USB (Mini-B plug female) |

2.3 USB Cable Specifications

| | |
|--------------------|--|
| Signal name (Port) | To FX-USB-AW: USB (Mini-B plug male) To PC: USB (A plug male) |
| Length of cable | 5m (196.9") at most (Included cable is 3m(118.1").) |

2.4 System Requirements

| | |
|-------------------------|---|
| OS | Microsoft® Windows® 98*1, Windows® 98SE*1 Microsoft® Windows® Millennium Edition (Windows® Me)*1 Microsoft® Windows® 2000*1 Microsoft® Windows® XP*2*3 Microsoft® Windows Vista®*2*3 Microsoft® Windows® 7*4 Microsoft® Windows® 8*5 Microsoft® Windows® 8.1*6 |
| Software | GX Works2 (SWDDNC-GXW2-J, SWDDNC-GXW2-E) GX Developer (SWDD5C-GPPW-J, SWDD5C-GPPW-E) FX-PCS/WIN*7, FX-PCS/WIN-E*8 FX-PCS-VPS/WIN, FX-PCS-VPS/WIN-E |
| Programmable controller | FX0, FX0S, FX0N, FX1S, FX1N, FX2N, FX3U, FX1NC*9, FX2NC, FX3UC, FX2N-10GM, FX2N-20GM, FX2N-1RM(-E)-SET |

*1 Use the USB driver for Windows® 98, Windows® 98SE, Windows® Millennium Edition and Windows® 2000 included in the USB driver software Ver. 1.60.

*2 Use the USB driver for Windows® XP and Windows Vista® included in the USB driver software Ver. 1.60.

*3 Only the 32-bit version of this operating system is supported.

*4 USB driver Ver. 1.30 or later is applicable to Windows® 7 32-bit version. USB driver Ver. 1.40 or later is applicable to Windows® 7 64-bit version. Use the applicable USB driver for Windows® 7 included in the USB driver software Ver. 1.60.

*5 Use the USB driver for Windows® 8 included in the USB driver software Ver. 1.60.

*6 Use the USB driver for Windows® 8.1 included in the USB driver software Ver. 1.60.

*7 FX-PCS/WIN for versions earlier than 4.30, the communication port setting can be selected from COM1-COM4.

For versions 4.30 or later, the communication port setting can be selected from COM1-COM9.

*8 FX-PCS/WIN-E for versions earlier than 3.30, the communication port setting can be selected from COM1-COM4.

For versions 3.30 or later, the communication port setting can be selected from COM1-COM9.

*9 FX1NC Series PLC specification details for I/O, wiring, installation, and maintenance can only be found in the Japanese Manual.

3. System Configuration

Connected equipment and connected cable

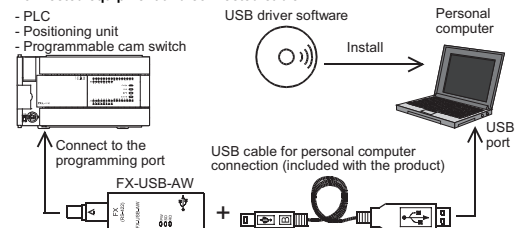

| Connected equipment | Baud rate | Cable for personal computer connection |
|---|----------------------|--|
| FX0, FX0S, FX0N, FX1S | 9.6 kbps | USB cable of 5m (196.9") at most (Included cable is 3m (118.1")) |
| FX1N, FX1NC*1 | 19.2 kbps or less | |
| FX2N (Earlier than Ver. 3.00), FX2NC (Earlier than Ver. 3.00) | 9.6 kbps | |
| FX2N (Ver. 3.00 or later), FX2NC (Ver. 3.00 or later) | 19.2 kbps or less | |
| FX3U, FX3UC | 115.2 kbps or less | |
| Positioning unit | FX2N-10GM, FX2N-20GM | 9.6 kbps |
| Programmable cam switch | FX2N-1RM-E-SET | 9.6 kbps |

*1 FX1NC Series PLC specification details for I/O, wiring, installation, and maintenance can only be found in the Japanese Manual.
Please refer to the specific PLC manual for a PLC not mentioned above.

4. Connecting Procedure

- Power off the PLC.
- Connect the USB (Mini-B plug male) connector of the USB cable to the FX-USB-AW.
- Connect the RS-422 (Mini-DIN 8Pin male) connector of the FX-USB-AW to the PLC.
- Connect the USB (A plug male) connector of the USB cable to the personal computer.
- Power ON the PLC.
- Power ON the personal computer.
- Make sure the POWER lamp of the FX-USB-AW is lit.
(The POWER lamp of FX-USB-AW lights when power is supplied normally by the personal computer.)

5. Driver Installation

Please connect the USB cable to the personal computer. Install USB driver software from the included CD-ROM.

Caution

- Please confirm whether the installation is performed normally after the installation of the driver. Regarding confirmation, refer to Chapter 6.
- The driver is not installed properly when the process is canceled during installation. To complete installation, uninstall the driver, and install again. For the uninstallation procedure of the driver, refer to the following manual.
→ FX-USB-AW/FX3U-USB-BD User's Manual - USB Driver Installation Edition
- This product requires USB Driver Installation for each USB port to be used. To use multiple USB ports, connect this product to each port, and install the driver each time.
The driver is not installed properly if the driver of a different version has already been installed. To complete installation, uninstall the driver, and install again. (With Windows Vista®, Windows® 7 or Windows® 8/8.1, driver installation will occur automatically.
In other OS, depending on the PC environment, driver installation may occur automatically, or the location for the file may be required to be specified.)

USB driver software (Ver. 1.60) folder structure

| <CD-ROM Drive> | Content |
|-----------------|--|
| <Win2000_ME_98> | The USB driver for Windows® 98, Windows® 98SE, Windows® Millennium Edition (Me) and Windows® 2000 is stored. |
| <WinVista_XP> | The USB driver for Windows® XP and Windows Vista® is stored. |
| <Win7> | The USB driver for Windows® 7 32-bit version is stored. |
| <Win7_64> | The USB driver for Windows® 7 64-bit version is stored. |
| <Win8> | The USB driver for Windows® 8 is stored. |
| <Win8_1> | The USB driver for Windows® 8.1 is stored. |

5.1 Windows® 98, Windows® 98SE, Windows® Millennium Edition, Windows® 2000, and Windows® XP

Please install the driver with the following procedure.

The installation procedure is explained when connecting to a personal computer with Windows® XP.

- Installation methods for Windows® 98, Windows® 98SE, Windows® Millennium Edition, and Windows® 2000 will vary.

- 1) When the USB cable is connected to the personal computer, the following screen is displayed.



Insert the included CD-ROM into the personal computer's CD-ROM drive.

Click [Next >].

The installation of the USB driver software will begin.

- If using Windows® 98 or Windows® 98SE

A window to select the location of the installation files will appear.

Specify the USB driver software version as follows:

Ver. 1.20 or later

Please select "Include this location in the search", and install by specifying the "Win2000_ME_98" directory in the CD-ROM drive.

Ver. 1.10

Please select "Include this location in the search", and install by specifying the "WinXP_2000_ME_98" directory in the CD-ROM drive.

Versions previous to Ver. 1.10

Please select the CD-ROM drive.

- If using Windows® Millennium Edition or Windows® 2000

A window to select the location of the installation files will appear.

Please select the CD-ROM drive.

- 2) The following screen is displayed. (Only in Windows® XP)

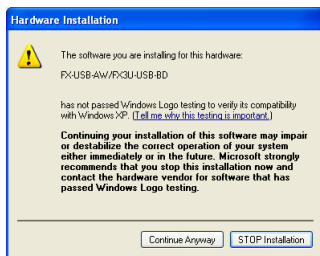

Click [Continue Anyway].

- 3) The completion screen is displayed.

Click [Finish].

If using Windows® 2000 or Windows® XP, proceed to step 4).

- If using Windows® 98, Windows® 98SE or Windows® Millennium Edition is used, installation of the USB Serial Port software begins, and ends automatically.

The CD-ROM can be removed from the personal computer at this time.

The installation of the USB driver software is completed.

Next, please confirm whether the installation is performed normally.

Regarding confirmation, refer to Chapter 6.

- 4) The following screen is displayed.



Click [Next >].

The installation of the USB Serial Port software will begin.

- If using Windows® 2000, a screen to select the location of the installation files is displayed.

Please select the CD-ROM drive.

- 5) The screen of 2) is displayed. (Only in Windows® XP)

Click [Continue Anyway].

- 6) The completion screen is displayed.

Click [Finish].

The installation of the USB Serial Port software will finish.

The CD-ROM (USB driver software) can be removed from the personal computer at this time.

Next, please confirm whether the installation is performed normally. Regarding confirmation, refer to Chapter 6.

5.2 Windows Vista®, Windows® 7, Windows® 8/8.1

For the installation procedure of the driver, refer to the following manual.

→ FX-USB-AW/FX3u-USB-BD User's Manual - USB Driver Installation Edition

6. Installation Confirmation of Driver

Procedure for confirming the installation of the driver is described below.

Please perform the following procedure, where the FX-USB-AW is connected to the personal computer.

Windows® XP example follows.

- In Windows® XP, click [Start] → [Control Panel] → [Performance and Maintenance] → [System] → [Hardware] → [Device Manager] and the window below will be displayed.

Please confirm the COM number to which the driver is allocated (COM and LPT).

- If using Windows® 98, Windows® 98SE, Windows® Millennium Edition or Windows® 2000

A screen that is equivalent to the one below is displayed by clicking [My Computer] → [Control Panel] → [System] → [Device Manager] in the menu of the personal computer.

- If using Windows Vista®

A screen that is equivalent to the one below is displayed by clicking [Start] → [Control Panel] → [Hardware and Sound] → [Device Manager] in the menu of the personal computer.

- If using Windows® 7

A screen that is equivalent to the one below is displayed by clicking [Start] → [Control Panel] → [System and Security] → [Device Manager] in the menu of the personal computer.

- If using Windows® 8/8.1

A screen that is equivalent to the one below is displayed by clicking [Start] → [All apps] → [Control Panel] → [System and Security] → [Device Manager] in the menu of the personal computer.

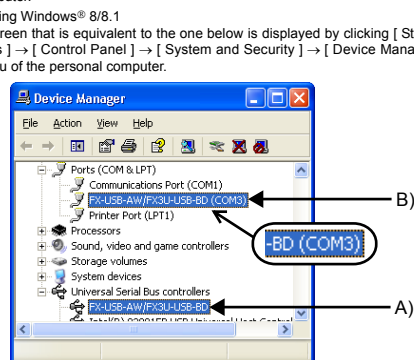

Check following:

- 1) "FX-USB-AW/FX3U-USB-BD" is displayed at A), as part of the list of the "Universal Serial Bus controllers".
- 2) "FX-USB-AW/FX3U-USB-BD (COM*)" is displayed at B), as part of the serial port list.
 - * indicates the COM number used in FX-USB-AW.
- 3) is not displayed.

Identification result:

- If 1) through 3) are all confirmed, installation is normal.
 - Select the programming software COM number as the COM number currently assigned on the screen above.
- If any one of 1) through 3) is not satisfied, installation is not normal. (If the USB serial port software is not installed or the installation procedure is canceled in process are possible causes)
 - In this case, please start the installation procedure again from the beginning, after uninstalling the driver. For the installation procedure of the driver, refer to Chapter 5. For the uninstallation procedure of the driver, refer to the following manual.
 - FX-USB-AW/FX3u-USB-BD User's Manual - USB Driver Installation Edition

7. Uninstalling Driver

For the uninstallation procedure of the driver, refer to the following manual.

→ FX-USB-AW/FX3u-USB-BD User's Manual - USB Driver Installation Edition

8. Caution on Use

| STARTUP AND MAINTENANCE PRECAUTIONS | ⚠ WARNING |
|--|-----------|
| <ul style="list-style-type: none"> • Before modifying or disrupting the program in operation or running the PLC, carefully read through this manual and the associated manuals and ensure the safety of the operation. • An operation error may damage the machinery or cause accidents. | |

| STARTUP AND MAINTENANCE PRECAUTIONS | ⚠ CAUTION |
|---|-----------|
| <ul style="list-style-type: none"> • Do not disassemble or modify the PLC. <ul style="list-style-type: none"> Doing so may cause fire, equipment failures, or malfunctions. For repair, contact your local Mitsubishi Electric representative. • Since the FX-USB-AW case is made of resin, do not drop it or exert strong impact to it. <ul style="list-style-type: none"> Doing so may cause damage. | |

| DISPOSAL PRECAUTIONS | ⚠ CAUTION |
|--|-----------|
| <ul style="list-style-type: none"> • Please contact a certified electronic waste disposal company for the environmentally safe recycling and disposal of your device. | |

| TRANSPORTATION AND STORAGE PRECAUTIONS | ⚠ CAUTION |
|--|-----------|
| <ul style="list-style-type: none"> • The product is a precision instrument. During transportation, avoid any impacts. <ul style="list-style-type: none"> Failure to do so may cause failures in the product. After transportation, verify the operations of the product. | |

- FX-USB-AW and a personal computer are connected and the PLC is turned on, and then operations such as write, read, and monitor are tried for the first time using a programming tool, a communication error message may be displayed. In such a case, clear the message and try the operations again.
- If a communication error message appears while operating the programming tool (when executing "Write to PLC", "Read from PLC", or "Monitor"), disconnect the USB cable once (from either the PC or the FX-USB-AW) and connect it again. Then clear the error message and choose Write, Read, or Monitor again.
- The programming tool may not be operated properly due to a contact failure at connectors or wire breakage.
 - Make sure to save the program before transferring or changing it.

9. Troubleshooting

- If communication cannot be established between the PLC (as well as a positioning unit or a programmable cam switch) and a PC using the FX-USB-AW, confirm the following status by checking the POWER LED, SD LED, and RD LED in the FX-USB-AW.

| State of the POWER LED | Contents |
|------------------------|--|
| POWER LED is lit | The 5V DC power supply from the personal computer is normally supplied. In case of no communication, check the status of SD LED and RD LED. |
| POWER LED is not lit | The 5V DC power supply from the personal computer is not supplied. Check the items below. <ul style="list-style-type: none"> • Confirm that the specified cable is used to connect the FX-USB-AW and the personal computer. • Confirm whether the power supply is supplied to personal computer. |

| The status of the SD LED and RD LED | Contents |
|-------------------------------------|--|
| Blinking | Communicating correctly |
| SD OFF | <ul style="list-style-type: none"> • Confirm that the power is supplied to the personal computer. • Confirm the personal computer and the PLC are connected properly with the specified cable. • Confirm that the communication settings, such as the COM number, and connected PLC are correctly set in the software. Refer to the software manual. • Please check whether the driver can be installed normally. Regarding confirmation, refer to Chapter 6. |
| Blinking | Data receiving |
| RD OFF | <ul style="list-style-type: none"> • Confirm that the power is supplied to PLC. • The PLC will not operate when a configuration that exceeds the 5V DC or 24V DC capacity is used. <ul style="list-style-type: none"> It will also be impossible to communicate normally. • Confirm that the specified cable is used to connect the personal computer and PLC. • Confirm that the communication settings, such as the COM number, connected PLC are correctly set in the software. Refer to the software manual. • Please check whether the driver can be installed normally. Regarding confirmation, refer to Chapter 6. |

- When driver installation is required after already establishing USB communication.
 - This product requires USB Driver Installation for each USB port to be connected. Connect the product to a driver-installed USB port, or install the driver for the current port.
 - The driver is not installed properly if the driver of a different version has already been installed. To complete installation, uninstall the driver, and install again.

This manual confers no industrial property rights or any rights of any other kind, nor does it confer any patent licenses. Mitsubishi Electric Corporation cannot be held responsible for any problems involving industrial property rights which may occur as a result of using the contents noted in this manual.

Warranty

Mitsubishi will not be held liable for damage caused by factors found not to be the cause of Mitsubishi; opportunity loss or lost profits caused by faults in the Mitsubishi products; damage, secondary damage, accident compensation caused by special factors unpredictable by Mitsubishi; damages to products other than Mitsubishi products; and to other duties.

| ⚠ For safe use |
|---|
| <ul style="list-style-type: none"> • This product has been manufactured as a general-purpose part for general industries, and has not been designed or manufactured to be incorporated in a device or system used in purposes related to human life. • Before using the product for special purposes such as nuclear power, electric power, aerospace, medicine or passenger movement vehicles, consult with Mitsubishi Electric. • This product has been manufactured under strict quality control. However when installing the product where major accidents or losses could occur if the product fails, install appropriate backup or failsafe functions in the system. |

MITSUBISHI ELECTRIC CORPORATION

HEAD OFFICE : TOKYO BUILDING, 2-7-3 MARUNOUCHI, CHIYODA-KU, TOKYO 100-8310, JAPAN



PROGRAMMABLE CONTROLLERS
MELSEC-F

FX-USB-AW
USER'S MANUAL

| | |
|---------------|-------------|
| Manual Number | JY997D13201 |
| Revision | N |
| Date | April 2015 |



This manual describes the part names, dimensions, mounting, and specifications of the product. Before use, read this manual and the manuals of all relevant products fully to acquire proficiency in handling and operating the product. Make sure to learn all the product information, safety information, and precautions. Store this manual in a safe place so that it can be taken out and read whenever necessary. Always forward it to the end user.

Registration: Microsoft®, Windows® and Windows Vista® are either registered trademarks or trademarks of Microsoft Corporation in the United States and/or other countries. The company and product names described in this manual are registered trademarks or the trademarks of their respective companies.

Effective April 2015
Specifications are subject to change without notice.
© 2004 Mitsubishi Electric Corporation

Safety Precaution (Read these precautions before use.)

This manual classifies the safety precautions into two categories:

| | |
|----------------|---|
| WARNING | Indicates that incorrect handling may cause hazardous conditions, resulting in death or severe injury. |
| CAUTION | Indicates that incorrect handling may cause hazardous conditions, resulting in medium or slight personal injury or physical damage. |

Depending on the circumstances, procedures indicated by **CAUTION** may also cause severe injury. It is important to follow all precautions for personal safety.

Associated Manuals

| Manual name | Manual No. | Description |
|--|-----------------------------------|---|
| FX-USB-AW /FX3U-USB-BD User's Manual - USB Driver Installation Edition | JY997D32601 | Explains procedures for installing the USB driver software for the FX-USB-AW or FX3U-USB-BD. |
| FX Series User's Manual - Data Communication Edition | JY997D16901 MODEL CODE: 09R715 | Explains N:N network, Parallel Link, Computer Link, Non-Protocol communication by RS and RS2 instructions/FX2N-232IF. |

How to obtain manuals
For product manuals or documents, consult with the Mitsubishi Electric dealer from who you purchased your product.

Notification of CE marking
This notification does not guarantee that an entire mechanical module produced in accordance with the contents of the notification comply with the following standards. Compliance to EMC standards of the entire mechanical module should be checked by the user / manufacturer.

Attention
• This product is designed for use in industrial applications.

Note
• Authorized Representative in the European Community:
Mitsubishi Electric Europe B.V.
Gothaer Str. 8, 40880 Ratingen, Germany

Standards with which this product complies

Type: Programmable Controller (Open Type Equipment)
Models: Products manufactured from August 1st, 2004.

| Electromagnetic Compatibility Standards (EMC) | Remark |
|---|---|
| EN61000-6-4:2007 Generic emission standard Industrial environment | Compliance with all relevant aspects of the standard. (Emission-Enclosure port, Emission-Low voltage AC mains port and Emission-Telecommunications/network port) |
| EN61131-2:2007 Programmable controllers - Equipment requirements and tests | Compliance with all relevant aspects of the standard. (Radiated Emission, Conducted Emission, Radiated electromagnetic field, Fast transient burst, Electrostatic discharge, High-energy surge, Voltage drops and interruptions, Conducted RF and Power frequency magnetic field) |
| EN61000-6-2:2005 Generic immunity standard Industrial environment | Compliance with all relevant aspects of the standard. (Radio-frequency electromagnetic field, Amplitude modulated, Fast transients, Electrostatic discharge, Surges, Voltage dips, Voltage interruptions, Radio-frequency common mode and Power-frequency magnetic field) |

Notes for compliance to EMC regulation.
It is necessary to install the (FX-USB-AW) in a shielded metal control panel. For more details please contact the local Mitsubishi Electric sales site.

1. Outline

The FX-USB-AW is a RS-422/USB conversion interface unit to connect the FX series PLC to a personal computer with USB ports.

1.1 Incorporated Items

Verify that the following product and items are included in the package:

| | |
|-----------------------|--|
| Product | FX-USB-AW type interface unit |
| Included items | USB driver software (CD-ROM) USB cable (3m (118.1")) User's Manual (this manual) |

1.2 External Dimensions and Part Names

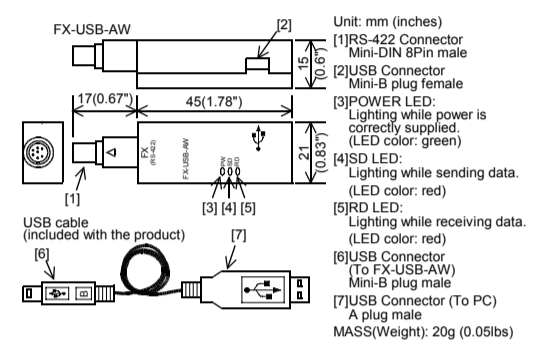

2. Specifications

| INSTALLATION PRECAUTIONS | CAUTION |
|--|---------|
| <ul style="list-style-type: none"> Use the product within the generic environment specifications described in PLC main unit manual (Hardware Edition). Never use the product in areas with excessive dust, oily smoke, conductive dusts, corrosive gas (salt air, Cl₂, H₂S, SO₂ or NO₂), flammable gas, vibration or impacts, or expose it to high temperature, condensation, or rain and wind. If the product is used in such conditions, electric shock, fire, malfunctions, deterioration or damage may occur. | |

2.1 General Specifications

The general specifications are equivalent to the PLC main unit. For general specifications, refer to the manual of the PLC main unit.

2.2 Performance Specifications of FX-USB-AW

| | |
|----------------------------|--|
| Current consumption | <ul style="list-style-type: none"> 15mA / 5V DC (5V DC power is supplied from the internal power supply of PLC) 30mA / 5V DC (5V DC power is supplied from the USB connector of personal computer) |
|----------------------------|--|

| | | | | | |
|------------------------------|--|--------|-----------------------------|----------|--------------------------|
| Level Conversion | Bidirectional between RS-422 and USB (Between signals are isolated by photocoupler.) | | | | |
| Baud Rate | 115200 bps, maximum (The baud rate is different in PLC.) | | | | |
| Transmission standard | USB2.0 (For full speed) | | | | |
| Signal name (Port) | <table border="1"> <tr> <td>To PLC</td> <td>RS-422 (Mini-DIN 8Pin male)</td> </tr> <tr> <td>To cable</td> <td>USB (Mini-B plug female)</td> </tr> </table> | To PLC | RS-422 (Mini-DIN 8Pin male) | To cable | USB (Mini-B plug female) |
| To PLC | RS-422 (Mini-DIN 8Pin male) | | | | |
| To cable | USB (Mini-B plug female) | | | | |

2.3 USB Cable Specifications

| | | |
|---------------------------|--|------------------------|
| Signal name (Port) | To FX-USB-AW | USB (Mini-B plug male) |
| | To PC | USB (A plug male) |
| Length of cable | 5m (196.9") at most (Included cable is 3m(118.1")) | |

2.4 System Requirements

| | |
|--------------------------------|---|
| OS | Microsoft® Windows® 98*1, Windows® 98SE*1 Microsoft® Windows® Millennium Edition (Windows® Me)*1 Microsoft® Windows® 2000*1 Microsoft® Windows® XP*2*3 Microsoft® Windows Vista®*2*3 Microsoft® Windows® 7*4 Microsoft® Windows® 8*5 Microsoft® Windows® 8.1*6 |
| Software | GX Works2 (SWD5C-GXW2-J, SWD5C-GXW2-E) GX Developer (SWD5C-GPPW-J, SWD5C-GPPW-E) FX-PCS/WIN*7, FX-PCS/WIN-E*8 FX-PCS-VPS/WIN, FX-PCS-VPS/WIN-E |
| Programmable controller | FX0, FX0S, FX0N, FX1S, FX1N, FX2N, FX3U, FX1NC*9, FX2NC, FX3UC, FX2N-10GM, FX2N-20GM, FX2N-1RM-(E)-SET |

- *1 Use the USB driver for Windows® 98, Windows® 98SE, Windows® Millennium Edition and Windows® 2000 included in the USB driver software Ver. 1.60.
- *2 Use the USB driver for Windows® XP and Windows Vista® included in the USB driver software Ver. 1.60.
- *3 Only the 32-bit version of this operating system is supported.
- *4 USB driver Ver. 1.30 or later is applicable to Windows® 7 32-bit version. USB driver Ver. 1.40 or later is applicable to Windows® 7 64-bit version. Use the applicable USB driver for Windows® 7 included in the USB driver software Ver. 1.60.
- *5 Use the USB driver for Windows® 8 included in the USB driver software Ver. 1.60.
- *6 Use the USB driver for Windows® 8.1 included in the USB driver software Ver. 1.60.
- *7 FX-PCS/WIN for versions earlier than 4.30, the communication port setting can be selected from COM1-COM4.
- *8 FX-PCS/WIN-E for versions earlier than 3.30, the communication port setting can be selected from COM1-COM9.
- *9 FX1NC Series PLC specification details for I/O, wiring, installation, and maintenance can only be found in the Japanese Manual.

3. System Configuration

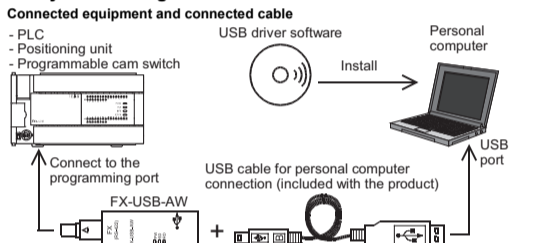

| Connected equipment | Baud rate | Cable for personal computer computer | |
|-------------------------|---|--------------------------------------|--|
| Programmable controller | FX0, FX0S, FX0N, FX1S FX1N, FX1NC*1 | 9.6 kbps 19.2 kbps or less | USB cable of 5m (196.9") at most (Included cable is 3m (118.1")) |
| | FX2N (Earlier than Ver. 3.00), FX2NC (Earlier than Ver. 3.00) | 9.6 kbps | |
| | FX2N (Ver. 3.00 or later), FX2NC (Ver. 3.00 or later) | 19.2 kbps or less | |
| Positioning unit | FX2N-10GM, FX2N-20GM | 9.6 kbps | USB cable of 5m (196.9") at most (Included cable is 3m (118.1")) |
| | Programmable cam switch | FX2N-1RM-E-SET | |

*1 FX1NC Series PLC specification details for I/O, wiring, installation, and maintenance can only be found in the Japanese Manual.
• Please refer to the specific PLC manual for a PLC not mentioned above.

4. Connecting Procedure

- Power off the PLC.
- Connect the USB (Mini-B plug male) connector of the USB cable to the FX-USB-AW.
- Connect the RS-422 (Mini-DIN 8Pin male) connector of the FX-USB-AW to the PLC.
- Connect the USB (A plug male) connector of the USB cable to the personal computer.
- Power ON the PLC.
- Power ON the personal computer.
- Make sure the POWER lamp of the FX-USB-AW is lit. (The POWER lamp of FX-USB-AW lights when power is supplied normally by the personal computer.)

5. Driver Installation

Please connect the USB cable to the personal computer. Install USB driver software from the included CD-ROM.

- Caution**
- Please confirm whether the installation is performed normally after the installation of the driver. Regarding confirmation, refer to Chapter 6.
 - The driver is not installed properly when the process is canceled during installation. To complete installation, uninstall the driver, and install again. For the uninstallation procedure of the driver, refer to the following manual.
→ FX-USB-AW/FX3U-USB-BD User's Manual - USB Driver Installation Edition
 - This product requires USB Driver Installation for each USB port to be used. To use multiple USB ports, connect this product to each port, and install the driver each time.
 - The driver is not installed properly if the driver of a different version has already been installed. To complete installation, uninstall the driver, and install again. (With Windows Vista®, Windows® 7 or Windows® 8/8.1, driver installation will occur automatically.)
 - In other OS, depending on the PC environment, driver installation may occur automatically, or the location for the file may be required to be specified.)

USB driver software (Ver. 1.60) folder structure

| | |
|----------------|---|
| <CD-ROM Drive> | <ul style="list-style-type: none"> <Win2000_ME_98> The USB driver for Windows® 98, Windows® 98SE, Windows® Millennium Edition (Me) and Windows® 2000 is stored. <WinVista_XP> The USB driver for Windows® XP and Windows Vista® is stored. <Win7> The USB driver for Windows® 7 32-bit version is stored. <Win7_64> The USB driver for Windows® 7 64-bit version is stored. <Win8> The USB driver for Windows® 8 is stored. <Win8_1> The USB driver for Windows® 8.1 is stored. |
|----------------|---|

5.1 Windows® 98, Windows® 98SE, Windows® Millennium Edition, Windows® 2000, and Windows® XP

Please install the driver with the following procedure. The installation procedure is explained when connecting to a personal computer with Windows® XP.

- Installation methods for Windows® 98, Windows® 98SE, Windows® Millennium Edition, and Windows® 2000 will vary.

1) When the USB cable is connected to the personal computer, the following screen is displayed.

4) The following screen is displayed.



- Click [Next >].
The installation of the USB Serial Port software will begin.
- If using Windows® 2000, a screen to select the location of the installation files is displayed. Please select the CD-ROM drive.
- 5) The screen of 2) is displayed. (Only in Windows® XP)
Click [Continue Anyway].
- 6) The completion screen is displayed.
Click [Finish].
The installation of the USB Serial Port software will finish. The CD-ROM (USB driver software) can be removed from the personal computer at this time.
Next, please confirm whether the installation is performed normally. Regarding confirmation, refer to Chapter 6.

5.2 Windows Vista®, Windows® 7, Windows® 8/8.1

For the installation procedure of the driver, refer to the following manual.
→ FX-USB-AW/FX3U-USB-BD User's Manual - USB Driver Installation Edition

6. Installation Confirmation of Driver

- Procedure for confirming the installation of the driver is described below. Please perform the following procedure, where the FX-USB-AW is connected to the personal computer.
- Windows® XP example follows.
- In Windows® XP, click [Start] → [Control Panel] → [Performance and Maintenance] → [System] → [Hardware] → [Device Manager] and the window below will be displayed. Please confirm the COM number to which the driver is allocated (COM and LPT).
 - If using Windows® 98, Windows® 98SE, Windows® Millennium Edition or Windows® 2000
A screen that is equivalent to the one below is displayed by clicking [My Computer] → [Control Panel] → [System] → [Device Manager] in the menu of the personal computer.
 - If using Windows Vista®
A screen that is equivalent to the one below is displayed by clicking [Start] → [Control Panel] → [Hardware and Sound] → [Device Manager] in the menu of the personal computer.
 - When user account control is enabled
Only when user account control is enabled will the "user account control" screen be displayed. Click [Continue], when displayed.
 - If using Windows® 7
A screen that is equivalent to the one below is displayed by clicking [Start] → [Control Panel] → [System and Security] → [Device Manager] in the menu of the personal computer.
 - If using Windows® 8/8.1
A screen that is equivalent to the one below is displayed by clicking [Start] → [All apps] → [Control Panel] → [System and Security] → [Device Manager] in the menu of the personal computer.

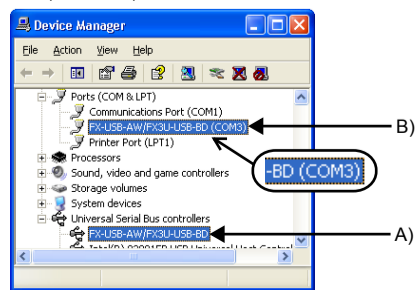

Check following:

- "FX-USB-AW/FX3U-USB-BD" is displayed at A), as part of the list of the "Universal Serial Bus controllers".
- "FX-USB-AW/FX3U-USB-BD (COM*)" is displayed at B), as part of the serial port list. * indicates the COM number used in FX-USB-AW.
- is not displayed.

- Identification result:**
- If 1) through 3) are all confirmed, installation is normal. Select the programming software COM number as the COM number currently assigned on the screen above.
 - If any one of 1) through 3) is not satisfied, installation is not normal. (If the USB serial port software is not installed or the installation procedure is canceled in process are possible causes)
In this case, please start the installation procedure again from the beginning, after uninstalling the driver. For the installation procedure of the driver, refer to Chapter 5. For the uninstallation procedure of the driver, refer to the following manual.
→ FX-USB-AW/FX3U-USB-BD User's Manual - USB Driver Installation Edition

7. Uninstalling Driver

For the uninstallation procedure of the driver, refer to the following manual.
→ FX-USB-AW/FX3U-USB-BD User's Manual - USB Driver Installation Edition

8. Caution on Use

| | |
|--|----------------|
| STARTUP AND MAINTENANCE PRECAUTIONS | WARNING |
| <ul style="list-style-type: none"> Before modifying or disrupting the program in operation or running the PLC, carefully read through this manual and the associated manuals and ensure the safety of the operation. An operation error may damage the machinery or cause accidents. | |
| STARTUP AND MAINTENANCE PRECAUTIONS | CAUTION |
| <ul style="list-style-type: none"> Do not disassemble or modify the PLC. Doing so may cause fire, equipment failures, or malfunctions. For repair, contact your local Mitsubishi Electric representative. Since the FX-USB-AW case is made of resin, do not drop it or exert strong impact to it. Doing so may cause damage. | |
| DISPOSAL PRECAUTIONS | CAUTION |
| <ul style="list-style-type: none"> Please contact a certified electronic waste disposal company for the environmentally safe recycling and disposal of your device. | |
| TRANSPORTATION AND STORAGE PRECAUTIONS | CAUTION |
| <ul style="list-style-type: none"> The product is a precision instrument. During transportation, avoid any impacts. Failure to do so may cause failures in the product. After transportation, verify the operations of the product. | |

- FX-USB-AW and a personal computer are connected and the PLC is turned on, and then operations such as write, read, and monitor are tried for the first time using a programming tool, a communication error message may be displayed. In such a case, clear the message and try the operations again.
- If a communication error message appears while operating the programming tool (when executing "Write to PLC", "Read from PLC", or "Monitor"), disconnect the USB cable once (from either the PC or the FX-USB-AW) and connect it again. Then clear the error message and choose Write, Read, or Monitor again.
- The programming tool may not be operated properly due to a contact failure at connectors or wire breakage. Make sure to save the program before transferring or changing it.

9. Troubleshooting

- If communication cannot be established between the PLC (as well as a positioning unit or a programmable cam switch) and a PC using the FX-USB-AW, confirm the following status by checking the POWER LED, SD LED, and RD LED in the FX-USB-AW.

| State of the POWER LED | Contents |
|-------------------------------------|--|
| POWER LED is lit | The 5V DC power supply from the personal computer is normally supplied. In case of no communication, check the status of SD LED and RD LED. |
| POWER LED is not lit | The 5V DC power supply from the personal computer is not supplied. Check the items below. <ul style="list-style-type: none"> Confirm that the specified cable is used to connect the FX-USB-AW and the personal computer. Confirm whether the power supply is supplied to personal computer. |
| The status of the SD LED and RD LED | |
| Blinking | Contents |
| Blinking | Communicating correctly |
| OFF | <ul style="list-style-type: none"> Confirm that the power is supplied to the personal computer. Confirm the personal computer and the PLC are connected properly with the specified cable. Confirm that the communication settings, such as the COM number, and connected PLC are correctly set in the software. Refer to the software manual. Please check whether the driver can be installed normally. Regarding confirmation, refer to Chapter 6. |
| Blinking | Data receiving |
| RD OFF | <ul style="list-style-type: none"> Confirm that the power is supplied to PLC. The PLC will not operate when a configuration that exceeds the 5V DC or 24V DC capacity is used. It will also be impossible to communicate normally. Confirm that the specified cable is used to connect the personal computer and PLC. Confirm that the communication settings, such as the COM number, connected PLC are correctly set in the software. Refer to the software manual. Please check whether the driver can be installed normally. Regarding confirmation, refer to Chapter 6. |

- When driver installation is required after already establishing USB communication.
→ This product requires USB Driver Installation for each USB port to be connected. Connect the product to a driver-installed USB port, or install the driver for the current port.
The driver is not installed properly if the driver of a different version has already been installed. To complete installation, uninstall the driver, and install again.

This manual confers no industrial property rights or any rights of any other kind, nor does it confer any patent licenses. Mitsubishi Electric Corporation cannot be held responsible for any problems involving industrial property rights which may occur as a result of using the contents noted in this manual.

Warranty
Mitsubishi will not be held liable for damage caused by factors found not to be the cause of Mitsubishi; opportunity loss or lost profits caused by faults in the Mitsubishi products; damage, secondary damage, accident compensation caused by special factors unpredictable by Mitsubishi; damages to products other than Mitsubishi products; and to other duties.

| |
|---|
| For safe use |
| <ul style="list-style-type: none"> This product has been manufactured as a general-purpose part for general industries, and has not been designed or manufactured to be incorporated in a device or system used in purposes related to human life. Before using the product for special purposes such as nuclear power, electric power, aerospace, medicine or passenger movement vehicles, consult with Mitsubishi Electric. This product has been manufactured under strict quality control. However when installing the product where major accidents or losses could occur if the product fails, install appropriate backup or failsafe functions in the system. |